



join-lamp.com[®]

**CATALOGO
CATALOGUE**

2018



join-lamp.com[®] THE SUSTAINABLE LIGHT 100% RECYCLABLE

BREVETTO E MARCHIO DI / PATENT AND TRADE MARK OF: SERGIO CATALANO

join-lamp.com di **SERGIO CATALANO**

via A. De Gasperi, tr. U. Foscolo, 3

84018 Scafati (Sa) ITALY

T/F +39 081 8508666

info@join-lamp.com

www.join-lamp.com

p.iva 02974760650

MADE IN ITALY

INTERNATIONAL PATENT

UTILITY MODEL

TRADE MARK

COPYRIGHT ON ARTIST DESIGN



THE SUSTAINABLE LIGHT 100% RECYCLABLE design SERGIO CATALANO

Le lampade della collezione join-lamp sono prodotte con un sistema di assemblaggio innovativo ed esclusivo, protetto da Brevetto Internazionale per Modello di Utilità. Esso consiste nell'assemblaggio di 2, 3, 4 o più componenti piani dotati di particolari tagli, e consente di realizzare diffusori autoportanti di forme e dimensioni variabili. Con semplice incastro e senza ausilio di altri componenti, supporti o accessori, tale diffusore trattiene una lampada o corpo luminoso a risparmio energetico e bassa emissione di calore. La combinazione tra vari tipi di lampade e componenti di diverso colore o forma, permette di realizzare una varietà infinita di apparecchi di illuminazione.



The lamps of join-lamp collection, are produced by an innovative and exclusive system of assembling, protected by international patent for utility model. It consists in the assembly of 2, 3, 4 or more components with special plans cuts, and allows you to create a self-supporting diffuser of different shapes and sizes. With a simple join and without the help of other components, brackets or accessories. that diffuser holds a energy saving bulb and low heat mission. The combination of different types of bulbs and components of different color or shape, leading to an infinite variety of lighting equipment.



THE SUSTAINABLE LIGHT 100% RECYCLABLE

ALADINA

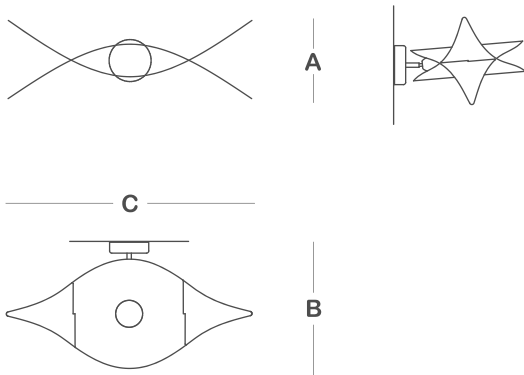

Confezione / Packaging Bag M



Nome / Name	ALADINA
Designer	SERGIO CATALANO
Versione / Version	PARETE / WALL
Dimensioni / Dimensions	A = 140mm B = 340mm C = 510mm
Codici colore / Code colors	<ul style="list-style-type: none"> ● W-ALA-A (arancio / orange) ● W-ALA-V (verde / green) ● W-ALA-R (rosso / red) ● W-ALA-L (lilla / lilac) ○ W-ALA-BA (bianco-arancio/white-orange) ○ W-ALA-BV (bianco-verde/white-green) ○ W-ALA-BR (bianco-rosso/white-red)
Materiali / Materials	PREMIUM acciaio verniciato / painted steel
Dimensioni confezione / Package size	12x40xh53cm
Lampada inclusa / Bulb included *	1x20W E27 FBG Ø95mm

* Le caratteristiche della lampada inclusa nella confezione potrebbero variare leggermente
The characteristics of lamp included in the package may vary slightly

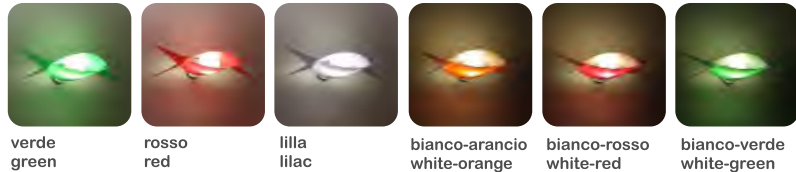

BREVETTO E MARCHIO DI / PATENT AND TRADE MARK OF: SERGIO CATALANO

join-lamp.com di SERGIO CATALANO
via A. De Gasperi, tr. U. Foscolo, 3
84018 Scafati (Sa) ITALY
T/F +39 081 8508666
info@join-lamp.com
www.join-lamp.com
p.iva 02974760650

MADE IN ITALY

INTERNATIONAL PATENT
UTILITY MODEL
TRADE MARK
COPYRIGHT ON ARTIST DESIGN





MARIPOSA

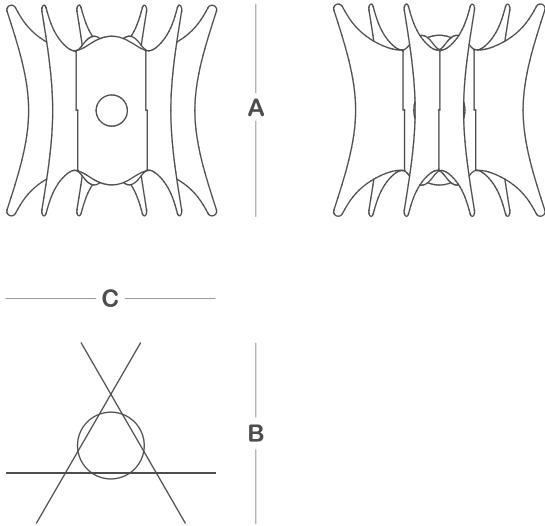

Confezione / Packaging Bag M



BREVETTO E MARCHIO DI / PATENT AND TRADE MARK OF: SERGIO CATALANO

join-lamp.com di **SERGIO CATALANO**
via A. De Gasperi, tr. U. Foscolo, 3
84018 Scafati (Sa) ITALY
T/F +39 081 8508666
info@join-lamp.com
www.join-lamp.com
p.iva 02974760650

Nome / Name	MARIPOSA
Designer	SERGIO CATALANO
Versione / Version	TAVOLO / TABLE
Dimensioni / Dimensions	A = 370mm B = 370mm C = 370mm
Codici colore / Code colors	<ul style="list-style-type: none"> ● T-MAR-A (arancio / orange) ● T-MAR-V (verde / green) ● T-MAR-R (rosso / red) ● T-MAR-L (lilla / lilac)
Materiali / Materials	PAPER
Dimensioni confezione / Package size	12x40xh53cm
Lampada inclusa / Bulb included *	1x20W E27 FBG Ø95mm

* Le caratteristiche della lampada inclusa nella confezione potrebbero variare leggermente
The characteristics of lamp included in the package may vary slightly



verde / green



rosso / red



arancio / orange

MADE IN ITALY

INTERNATIONAL PATENT
UTILITY MODEL
TRADE MARK
COPYRIGHT ON ARTIST DESIGN





ESPANA

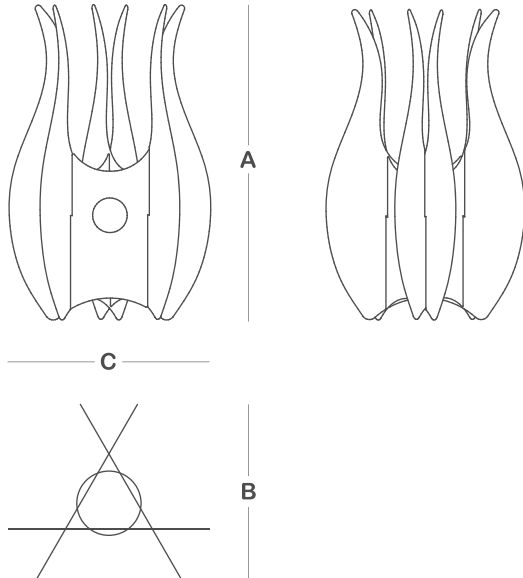

Confezione / Packaging
Bag M



Nome / Name	ESPANA
Designer	SERGIO CATALANO
Versione / Version	TAVOLO / TABLE
Dimensioni / Dimensions	A = 500mm B = 280mm C = 320mm
Codici colore / Code colors	<ul style="list-style-type: none"> ● T-ESP-A (arancio / orange) ● T-ESP-V (verde / green) ● T-ESP-R (rosso / red) ● T-ESP-L (lilla / lilac)
Materiali / Materials	PP/PE/PA
Dimensioni confezione / Package size	12x40xh53cm
Lampada inclusa / Bulb included *	1x20W E27 FBG Ø95mm

* Le caratteristiche della lampada inclusa nella confezione potrebbero variare leggermente
The characteristics of lamp included in the package may vary slightly



verde / green



rosso / red



lilla / lilac

BREVETTO E MARCHIO DI / PATENT AND TRADE MARK OF: SERGIO CATALANO

join-lamp.com di SERGIO CATALANO
via A. De Gasperi, tr. U. Foscolo, 3
84018 Scafati (Sa) ITALY
T/F +39 081 8508666
info@join-lamp.com
www.join-lamp.com
p.iva 02974760650

MADE IN ITALY

INTERNATIONAL PATENT
UTILITY MODEL
TRADE MARK
COPYRIGHT ON ARTIST DESIGN





AFRA

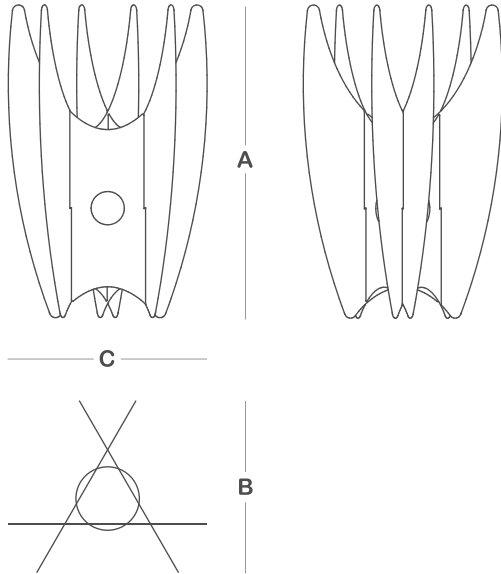

Confezione / Packaging
Bag M



Nome / Name	AFRA
Designer	SERGIO CATALANO
Versione / Version	TAVOLO / TABLE
Dimensioni / Dimensions	A = 520mm B = 290mm C = 330mm
Codici colore / Code colors	<ul style="list-style-type: none"> ● T-AFR-A (arancio / orange) ● T-AFR-V (verde / green) ● T-AFR-R (rosso / red) ● T-AFR-L (lilla / lilac)
Materiali / Materials	PLA / PC
Dimensioni confezione / Package size	12x40xh53cm
Lampada inclusa / Bulb included *	1x20W E27 FBG Ø95mm

* Le caratteristiche della lampada inclusa nella confezione potrebbero variare leggermente
The characteristics of lamp included in the package may vary slightly

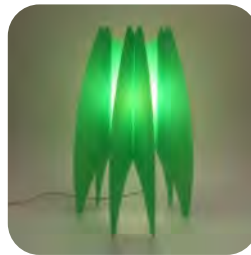

verde / green
posizione 2 / position 2



arancio / orange



lilla / lilac

BREVETTO E MARCHIO DI / PATENT AND TRADE MARK OF
SERGIO CATALANO
via A. De Gasperi, tr. U. Foscolo, 3
84018 Scafati (Sa) ITALY
T/F +39 081 8508666
info@join-lamp.com
www.join-lamp.com
p.iva 02974760650

MADE IN ITALY

INTERNATIONAL PATENT
UTILITY MODEL
TRADE MARK
COPYRIGHT ON ARTIST DESIGN





LABOR Table

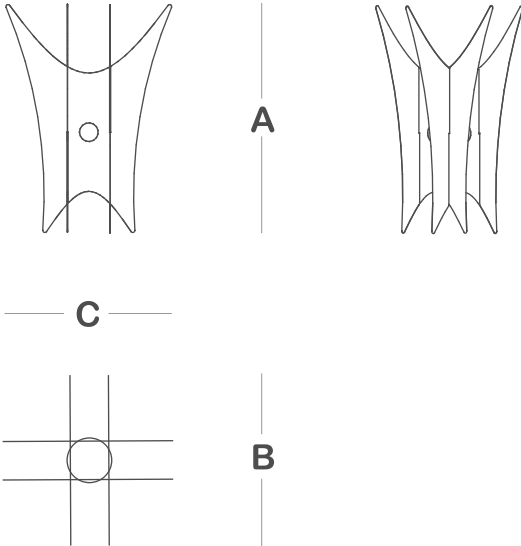

Confezione / Packaging Bag L Bag M



BREVETTO E MARCHIO DI / PATENT AND TRADE MARK OF
SERGIO CATALANO
 via A. De Gasperi, tr. U. Foscolo, 3
 84018 Scafati (Sa) ITALY
 T/F +39 081 8508666
 info@join-lamp.com
 www.join-lamp.com
 p.iva 02974760650

Nome / Name	LABOR Table	
Designer	SERGIO CATALANO	
Versione / Version	TAVOLO / TABLE	
Dimensioni / Dimensions	Labor T	A = 475mm B = 385mm C = 385mm
	Labor T L	A = 560mm B = 410mm C = 410mm
Codice / Code	Labor T	T-LAB-B (bianco/white)
	Labor T L	T-LABL-B (bianco/white)
Materiali / Materials	PAPER	
Dimensioni confezione / Package size	Labor T	Pack M - 12x40xh53cm
	Labor T L	Pack L - 16x71xh40cm
Lampada inclusa / Bulb included *	Labor T	1x20W E27 FBG Ø 95mm
	Labor T L	1x23W E27 FBG Ø120mm

* Le caratteristiche della lampada inclusa nella confezione potrebbero variare leggermente
 The characteristics of lamp included in the package may vary slightly

MADE IN ITALY

INTERNATIONAL PATENT
 UTILITY MODEL
 TRADE MARK
 COPYRIGHT ON ARTIST DESIGN





ALISA Table

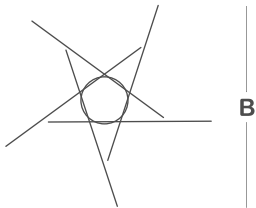
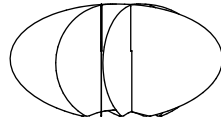
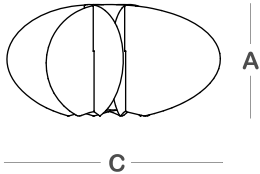

Confezione / Packaging
Bag M



BREVETTO E MARCHIO DI / PATENT AND TRADE MARK OF
SERGIO CATALANO
via A. De Gasperi, tr. U. Foscolo, 3
84018 Scafati (Sa) ITALY
T/F +39 081 8508666
info@join-lamp.com
www.join-lamp.com
p.iva 02974760650

Nome / Name	ALISA Table
Designer	SERGIO CATALANO
Versione / Version	TAVOLO / TABLE
Dimensioni / Dimensions	A = 275mm B = 520mm C = 530mm
Codice / Code	T-ALS-B (bianco/white)
Materiali / Materials	PP/PE/PS*
Dimensioni confezione / Package size	Pack M - 12x40xh53cm
Lampada inclusa / Bulb included *	1x20W E27 FBG Ø95mm

* Le caratteristiche della lampada inclusa nella confezione potrebbero variare leggermente
The characteristics of lamp included in the package may vary slightly

MADE IN ITALY

INTERNATIONAL PATENT
UTILITY MODEL
TRADE MARK
COPYRIGHT ON ARTIST DESIGN





LABOR Small - abat-jour

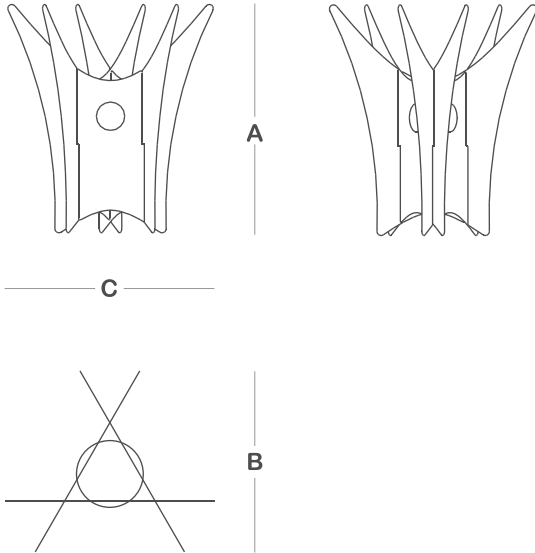

Confezione / Packaging Bag S



Nome / Name	LABOR Small
Designer	SERGIO CATALANO
Versione / Version	ABAT-JOUR
Dimensioni / Dimensions	A = 280mm B = 220mm C = 255mm
Codice / Code	<input type="radio"/> T-LABS-B (bianco/white) <input checked="" type="radio"/> T-LABS-A (arancio/orange) <input type="radio"/> T-LABS-V (verde/green) <input type="radio"/> T-LABS-R (rosso/red) <input type="radio"/> T-LABS-L (lilla/lilac)
Materiali / Materials	PP/PE/PV
Dimensioni confezione / Package size	Pack-bag S - 10x28xh32cm
Lampada inclusa / Bulb included *	1x9W E27 FBG Ø60mm

* Le caratteristiche della lampada inclusa nella confezione potrebbero variare leggermente
The characteristics of lamp included in the package may vary slightly



arancio / orange



verde / green

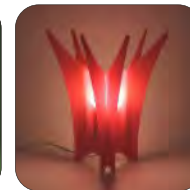

rosso / red



lilla / lilac



ECLIPSE Small - abat-jour

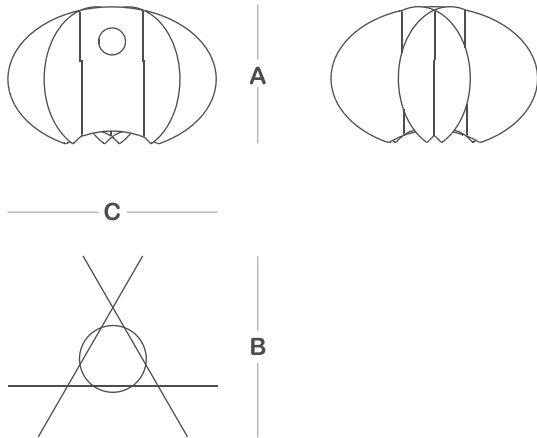

Confezione / Packaging Bag S



BREVETTO E MARCHIO DI / PATENT AND TRADE MARK OF
SERGIO CATALANO
 via A. De Gasperi, tr. U. Foscolo, 3
 84018 Scafati (Sa) ITALY
 T/F +39 081 8508666
 info@join-lamp.com
 www.join-lamp.com
 p.iva 02974760650

Nome / Name	ECLIPSE Small
Designer	SERGIO CATALANO
Versione / Version	ABAT-JOUR / TABLE
Dimensioni / Dimensions	A = 175mm B = 235mm C = 270mm
Codice / Code	<input type="radio"/> T-ECL-B (bianco/white) <input checked="" type="radio"/> T-ECL-A (arancio/orange) <input type="radio"/> T-ECL-V (verde/green) <input type="radio"/> T-ECL-R (rosso/red) <input type="radio"/> T-ECL-L (lilla/lilac)
Materiali / Materials	FRIPRE 100%
Dimensioni confezione / Package size	Pack-bag S - 10x28xh32cm
Lampada inclusa / Bulb included *	1x9W E27 FBG Ø60mm

* Le caratteristiche della lampada inclusa nella confezione potrebbero variare leggermente
 The characteristics of lamp included in the package may vary slightly

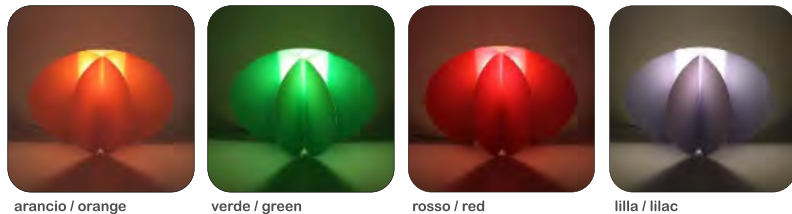

arancio / orange

verde / green

rosso / red

lilla / lilac

MADE IN ITALY

INTERNATIONAL PATENT
 UTILITY MODEL
 TRADE MARK
 COPYRIGHT ON ARTIST DESIGN





GEMMA

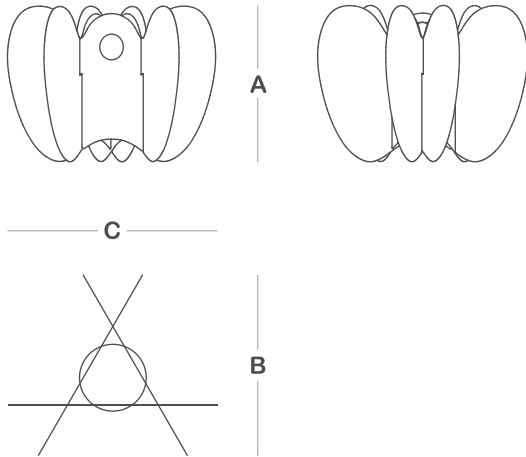

Confezione / Packaging Bag S



BREVETTO E MARCHIO DI / PATENT AND TRADE MARK OF
SERGIO CATALANO
 via A. De Gasperi, tr. U. Foscolo, 3
 84018 Scafati (Sa) ITALY
 T/F +39 081 8508666
 info@join-lamp.com
 www.join-lamp.com
 p.iva 02974760650

Nome / Name	GEMMA
Designer	SERGIO CATALANO
Versione / Version	ABAT-JOUR
Dimensioni / Dimensions	A = 195mm B = 230mm C = 260mm
Codici colore / Code colors	<ul style="list-style-type: none"> ● T-GEM-A (arancio / orange) ● T-GEM-V (verde / green) ● T-GEM-R (rosso / red) ● T-GEM-L (lilla / lilac)
Materiali / Materials	PP/PE/PA
Dimensioni confezione / Package size	10x28x32cm
Lampada inclusa / Bulb included *	1x9W E27 FBG Ø60mm

* Le caratteristiche della lampada inclusa nella confezione potrebbero variare leggermente
 The characteristics of lamp included in the package may vary slightly



verde / green



arancio / orange



lilla / lilac

MADE IN ITALY

INTERNATIONAL PATENT
 UTILITY MODEL
 TRADE MARK
 COPYRIGHT ON ARTIST DESIGN





MARIPOSA S

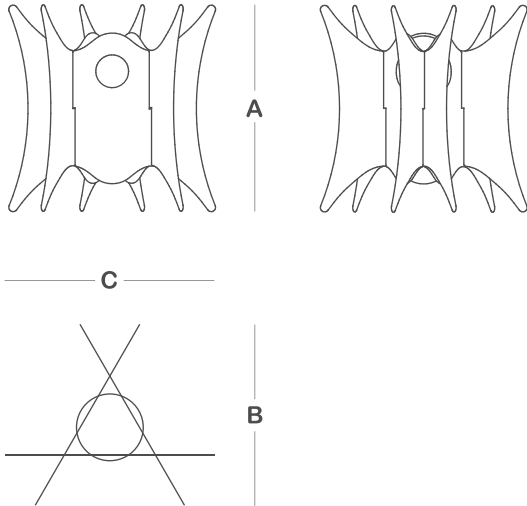

Nome / Name	MARIPOSA S
Designer	SERGIO CATALANO
Versione / Version	ABAT-JOUR
Dimensioni / Dimensions	A = 240mm B = 210mm C = 240mm
Codici colore / Code colors	<ul style="list-style-type: none"> ● T-MARS-A (arancio / orange) ● T-MARS-V (verde / green) ● T-MARS-R (rosso / red) ● T-MARS-L (lilla / lilac)
Materiali / Materials	PP/PE/PA
Dimensioni confezione / Package size	10x28x32cm
Lampada inclusa / Bulb included *	1x9W E27 FBG Ø60mm

* Le caratteristiche della lampada inclusa nella confezione potrebbero variare leggermente
The characteristics of lamp included in the package may vary slightly

Confezione / Packaging
Bag S



verde / green



rosso / red



lilla / lilac

BREVETTO E MARCHIO DI / PATENT AND TRADE MARK OF
SERGIO CATALANO
via A. De Gasperi, tr. U. Foscolo, 3
84018 Scafati (Sa) ITALY
T/F +39 081 8508666
info@join-lamp.com
www.join-lamp.com
p.iva 02974760650

MADE IN ITALY

INTERNATIONAL PATENT
UTILITY MODEL
TRADE MARK
COPYRIGHT ON ARTIST DESIGN





FLORES

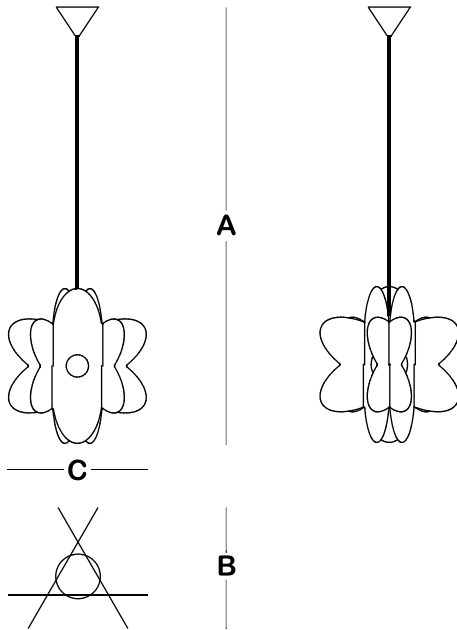

Confezione / Packaging
Bag M



Nome / Name	FLORES
Designer	SERGIO CATALANO
Versione / Version	SOSPENSIONE / SUSPENSION
Dimensioni / Dimensions	A = max1400mm B = 310mm C = 340mm
Codici colore / Code colors	<ul style="list-style-type: none"> ● F-FLO-A (arancio / orange) ● F-FLO-V (verde / green) ● F-FLO-R (rosso / red) ● F-FLO-L (lilla / lilac)
Materiali / Materials	rosone in PP / rosette in PP
Dimensioni confezione / Package size	12x40xh53cm
Lampada inclusa / Bulb included *	1x20W E27 FBG Ø95mm

* Le caratteristiche della lampada inclusa nella confezione potrebbero variare leggermente
The characteristics of lamp included in the package may vary slightly



verde / green



rosso / red



lilla / lilac



ECLIPSE

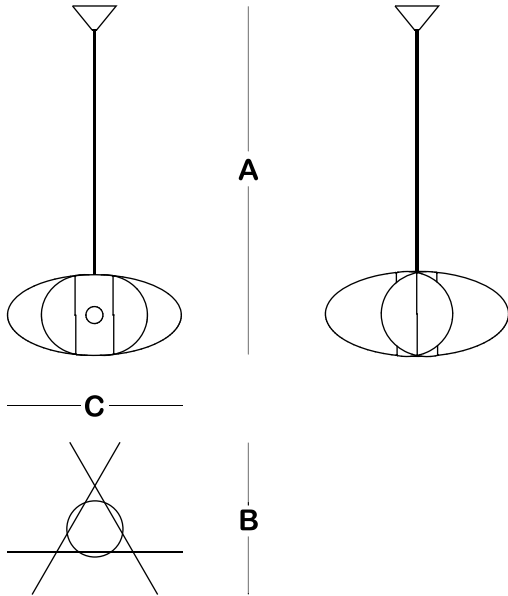

Confezione / Packaging
Bag M



Nome / Name	ECLIPSE
Designer	SERGIO CATALANO
Versione / Version	SOSPENSIONE / SUSPENSION
Dimensioni / Dimensions	A = max1400mm B = 480mm C = 560mm
Codici colore / Code colors	<ul style="list-style-type: none"> ● F-ECL-A (arancio / orange) ● F-ECL-V (verde / green) ● F-ECL-R (rosso / red) ● F-ECL-L (lilla / lilac)
Materiali / Materials	ROSETE rosone in PP / rosette in PP
Dimensioni confezione / Package size	12x40xh53cm
Lampada inclusa / Bulb included *	1x20W E27 FBG Ø95mm

* Le caratteristiche della lampada inclusa nella confezione potrebbero variare leggermente
The characteristics of lamp included in the package may vary slightly



verde / green



rosso / red



arancio / orange



THE SUSTAINABLE LIGHT 100% RECYCLABLE

ALIS

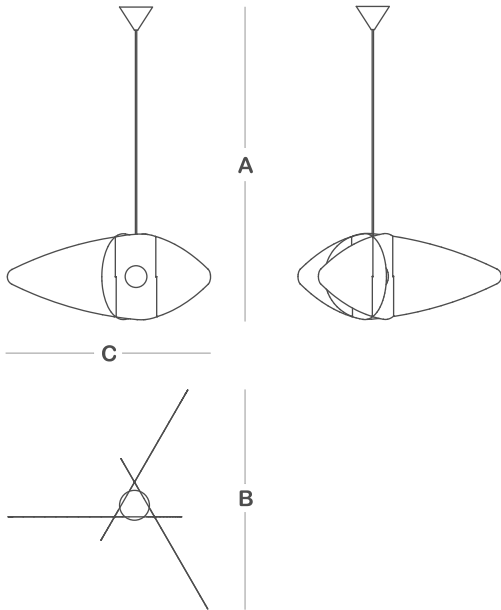

Confezione / Packaging
Bag L



Nome / Name	ALIS
Designer	SERGIO CATALANO
Versione / Version	SOSPENSIONE / SUSPENSION
Dimensioni / Dimensions	A = max1550mm B = 740mm C = 720mm
Codici colore / Code colors	<ul style="list-style-type: none"> ● S-ALI-A (arancio / orange) ● S-ALI-V (verde / green) ● S-ALI-R (rosso / red) ● S-ALI-L (lilla / lilac)
Materiali / Materials	<p>ROSETTA</p> rosone in PP / rosette in PP
Dimensioni confezione / Package size	16x71xh40cm
Lampada inclusa / Bulb included *	1x23W E27 FBG Ø120mm

* Le caratteristiche della lampada inclusa nella confezione potrebbero variare leggermente
The characteristics of lamp included in the package may vary slightly



verde / green



rosso / red



arancio / orange

BREVETTO E MARCHIO DI / PATENT AND TRADE MARK OF
SERGIO CATALANO
via A. De Gasperi, tr. U. Foscolo, 3
84018 Scafati (Sa) ITALY
T/F +39 081 8508666
info@join-lamp.com
www.join-lamp.com
p.iva 02974760650

MADE IN ITALY

INTERNATIONAL PATENT
UTILITY MODEL
TRADE MARK
COPYRIGHT ON ARTIST DESIGN





SPIN

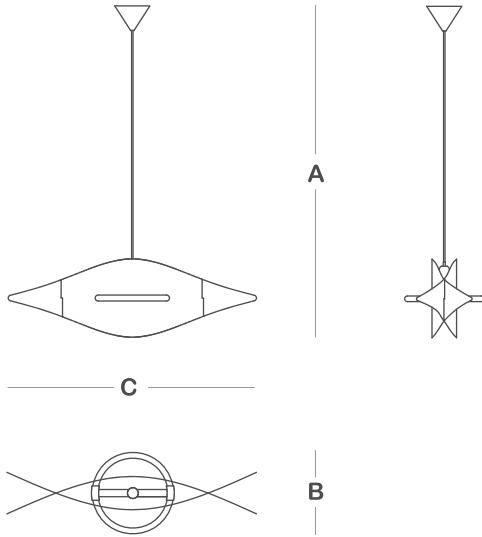

Confezione / Packaging Bag L



Nome / Name	SPIN
Designer	SERGIO CATALANO
Versione / Version	SOSPENSIONE / SUSPENSION
Dimensioni / Dimensions	A = max1500mm B = 225mm C = 660mm
Codici colore / Code colors	<ul style="list-style-type: none"> ● S-SPI-A (arancio / orange) ● S-SPI-V (verde / green) ● S-SPI-R (rosso / red) ● S-SPI-L (lilla / lilac) ○ S-SPI-BA (bianco-arancio/white-orange) ○ S-SPI-BV (bianco-verde/white-green) ○ S-SPI-BR (bianco-rosso/white-red)
Materiali / Materials	PRIPAN rosone in PP / rosette in PP
Dimensioni confezione / Package size	16x71xh40cm
Lampada inclusa / Bulb included *	1x24W E27 FBC Ø225mm

* Le caratteristiche della lampada inclusa nella confezione potrebbero variare leggermente
The characteristics of lamp included in the package may vary slightly



lilla
lilac

rosso
red

verde
green

bianco-verde
white-green

bianco-rosso
white-red

bianco-arancio
white-orange



THE SUSTAINABLE LIGHT 100% RECYCLABLE

MINOS

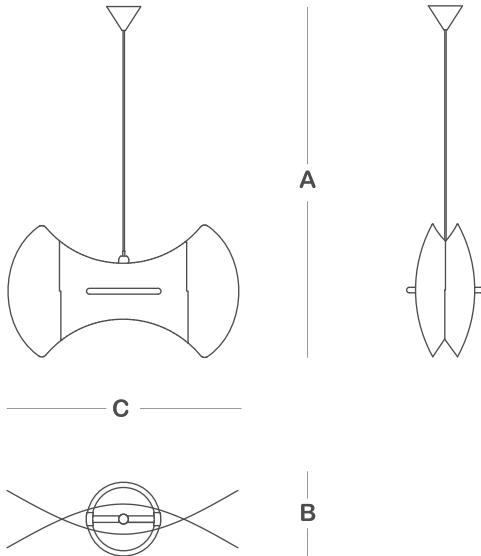

Confezione / Packaging Bag L



Nome / Name	MINOS
Designer	SERGIO CATALANO
Versione / Version	SOSPENSIONE / SUSPENSION
Dimensioni / Dimensions	A = max1550mm B = 225mm C = 660mm
Codici colore / Code colors	<ul style="list-style-type: none"> ● S-MIN-A (arancio / orange) ● S-MIN-V (verde / green) ● S-MIN-R (rosso / red) ● S-MIN-L (lilla / lilac) ○ S-MIN-BA (bianco-arancio/white-orange) ○ S-MIN-BV (bianco-verde/white-green) ○ S-MIN-BR (bianco-rosso/white-red)
Materiali / Materials	<p>FRIPLEX rosone in PP / rosette in PP</p>
Dimensioni confezione / Package size	16x71xh40cm
Lampada inclusa / Bulb included *	1x24W E27 FBC Ø225mm

* Le caratteristiche della lampada inclusa nella confezione potrebbero variare leggermente
The characteristics of lamp included in the package may vary slightly

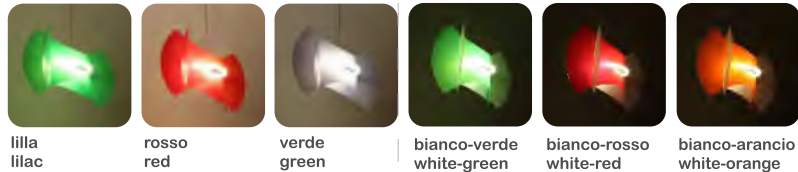

BREVETTO E MARCHIO DI / PATENT AND TRADE MARK OF
SERGIO CATALANO
via A. De Gasperi, tr. U. Foscolo, 3
84018 Scafati (Sa) ITALY
T/F +39 081 8508666
info@join-lamp.com
www.join-lamp.com
p.iva 02974760650

MADE IN ITALY

INTERNATIONAL PATENT
UTILITY MODEL
TRADE MARK
COPYRIGHT ON ARTIST DESIGN





LIBER_01

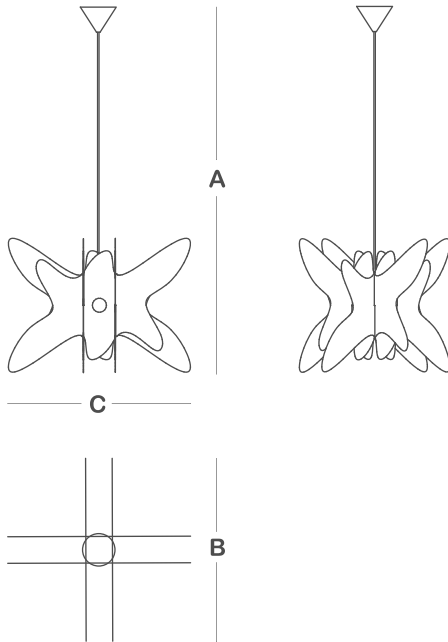

Confezione / Packaging
Bag L



Nome / Name	LIBER_01
Designer	SERGIO CATALANO
Versione / Version	SOSPENSIONE / SUSPENSION
Dimensioni / Dimensions	A = max1600mm B = 650mm C = 650mm
Codice / Code	<input type="radio"/> S-LIB-B (bianco/white) <input checked="" type="radio"/> S-LIB-BA (bianco-arancio/white-orange) <input type="radio"/> S-LIB-BV (bianco-verde/white-green) <input type="radio"/> S-LIB-BR (bianco-rosso/white-red)
Materiali / Materials	rosone in PP / rosette in PP
Dimensioni confezione / Package size	Pack-bag L - 16x71x40cm
Lampada inclusa / Bulb included *	1x23W E27 FBG Ø 120mm

* Le caratteristiche della lampada inclusa nella confezione potrebbero variare leggermente
The characteristics of lamp included in the package may vary slightly



bianco-arancio
white-orange



bianco-verde
white-green



bianco-rosso
white-red

BREVETTO E MARCHIO DI / PATENT AND TRADE MARK OF
SERGIO CATALANO
via A. De Gasperi, tr. U. Foscolo, 3
84018 Scafati (Sa) ITALY
T/F +39 081 8508666
info@join-lamp.com
www.join-lamp.com
p.iva 02974760650

MADE IN ITALY

INTERNATIONAL PATENT
UTILITY MODEL
TRADE MARK
COPYRIGHT ON ARTIST DESIGN





SOLUNA / SOLUNA Large

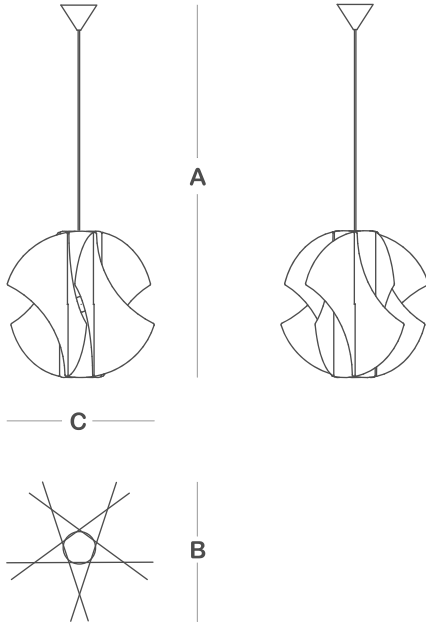

Confezione / Packaging
Bag L
Bag M



BREVETTO E MARCHIO DI / PATENT AND TRADE MARK OF

SERGIO CATALANO
via A. De Gasperi, tr. U. Foscolo, 3
84018 Scafati (Sa) ITALY
T/F +39 081 8508666
info@join-lamp.com
www.join-lamp.com
p.iva 02974760650

Nome / Name	SOLUNA / SOLUNA Large	
Designer	SERGIO CATALANO	
Versione / Version	SOSPENSIONE / SUSPENSION	
Dimensioni / Dimensions	Soluna A = max1550mm B = 350mm C = 350mm	Soluna L A = max1600mm B = 450mm C = 450mm
Codice / Code	Soluna <input type="radio"/> S-SOL-B (bianco/white) Soluna L <input type="radio"/> S-SOLL-B (bianco/white) Soluna L <input checked="" type="radio"/> S-SOLL-BA (bianco-arancio/white-orange) Soluna L <input type="radio"/> S-SOLL-BV (bianco-verde/white-green) Soluna L <input type="radio"/> S-SOLL-BR (bianco-rosso/white-red)	
Materiali / Materials	PP/PP rosone in PP / rosette in PP	
Dimensioni confezione / Package size	Soluna	Pack M - 12x40xh53cm
	Soluna L	Pack L - 16x71xh40cm
Lampada inclusa / Bulb included *	Soluna	1x20W E27 FBG Ø 95mm
	Soluna L	1x23W E27 FBG Ø120mm

* Le caratteristiche della lampada inclusa nella confezione potrebbero variare leggermente
The characteristics of lamp included in the package may vary slightly



bianco-arancio
white-orange



bianco-verde
white-green

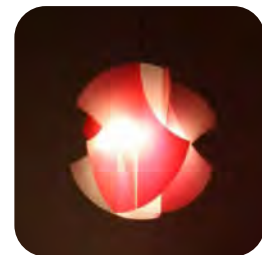

bianco-rosso
white-red

MADE IN ITALY

INTERNATIONAL PATENT
UTILITY MODEL
TRADE MARK
COPYRIGHT ON ARTIST DESIGN



OLUNA

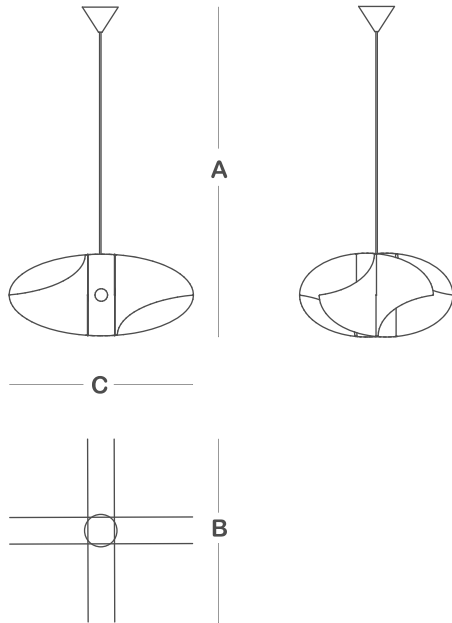

Confezione / Packaging
Bag L



Nome / Name	OLUNA
Designer	SERGIO CATALANO
Versione / Version	SOSPENSIONE / SUSPENSION
Dimensioni / Dimensions	A = max1540mm B = 700mm C = 700mm
Codice / Code	<input type="radio"/> S-OLU-B (bianco/white) <input checked="" type="radio"/> S-OLU-BA (bianco-arancio/white-orange) <input type="radio"/> S-OLU-BV (bianco-verde/white-green) <input type="radio"/> S-OLU-BR (bianco-rosso/white-red)
Materiali / Materials	PERIPAN rosone in PP / rosette in PP
Dimensioni confezione / Package size	Pack-bag L - 16x71x40cm
Lampada inclusa / Bulb included *	1x23W E27 FBG Ø 120mm

* Le caratteristiche della lampada inclusa nella confezione potrebbero variare leggermente
The characteristics of lamp included in the package may vary slightly



bianco-arancio
white-orange



bianco-verde
white-green



bianco-rosso
white-red

BREVETTO E MARCHIO DI / PATENT AND TRADE MARK OF
SERGIO CATALANO
 via A. De Gasperi, tr. U. Foscolo, 3
 84018 Scafati (Sa) ITALY
 T/F +39 081 8508666
 info@join-lamp.com
 www.join-lamp.com
 p.iva 02974760650

MADE IN ITALY

INTERNATIONAL PATENT
 UTILITY MODEL
 TRADE MARK
 COPYRIGHT ON ARTIST DESIGN



LABOR / LABOR Large

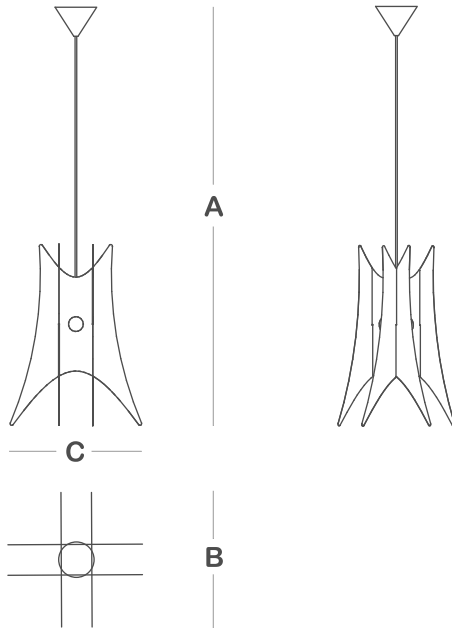

Confezione / Packaging Bag L Bag M



BREVETTO E MARCHIO DI / PATENT AND TRADE MARK OF
SERGIO CATALANO
 via A. De Gasperi, tr. U. Foscolo, 3
 84018 Scafati (Sa) ITALY
 T/F +39 081 8508666
 info@join-lamp.com
 www.join-lamp.com
 p.iva 02974760650

Nome / Name	LABOR / LABOR Large	
Designer	SERGIO CATALANO	
Versione / Version	SOSPENSIONE / SUSPENSION	
Dimensioni / Dimensions	Labor	A = max1635mm B = 385mm C = 385mm
	Labor L	A = max1695mm B = 410mm C = 410mm
Codice / Code	Labor	S-LAB-B (bianco/white)
	Labor L	S-LABL-B (bianco/white)
Materiali / Materials	PP/PP/PP rosone in PP / rosette in PP	
Dimensioni confezione / Package size	Labor	Pack M - 12x40xh53cm
	Labor L	Pack L - 16x71xh40cm
Lampada inclusa / Bulb included *	Labor	1x20W E27 FBG Ø 95mm
	Labor L	1x23W E27 FBG Ø120mm

* Le caratteristiche della lampada inclusa nella confezione potrebbero variare leggermente
 The characteristics of lamp included in the package may vary slightly

MADE IN ITALY

INTERNATIONAL PATENT
 UTILITY MODEL
 TRADE MARK
 COPYRIGHT ON ARTIST DESIGN





ALISA

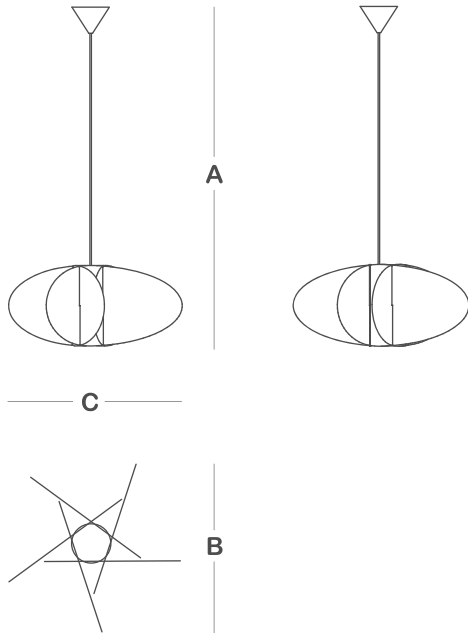

Confezione / Packaging
Bag L



Nome / Name	ALISA
Designer	SERGIO CATALANO
Versione / Version	SOSPENSIONE / SUSPENSION
Dimensioni / Dimensions	A = max1520mm B = 560mm C = 580mm
Codice / Code	<input type="radio"/> S-ALS-B (bianco/white) <input checked="" type="radio"/> S-ALS-BA (bianco-arancio/white-orange) <input type="radio"/> S-ALS-BV (bianco-verde/white-green) <input type="radio"/> S-ALS-BR (bianco-rosso/white-red)
Materiali / Materials	FORIPAN rosone in PP / rosette in PP
Dimensioni confezione / Package size	Pack-bag L - 16x71x40cm
Lampada inclusa / Bulb included *	1x23W E27 FBG Ø 120mm

* Le caratteristiche della lampada inclusa nella confezione potrebbero variare leggermente
The characteristics of lamp included in the package may vary slightly



bianco-arancio
white-orange



bianco-verde
white-green

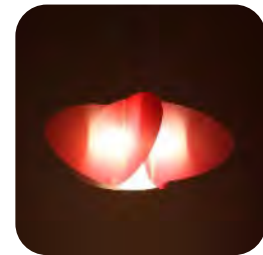

bianco-rosso
white-red

BREVETTO E MARCHIO DI / PATENT AND TRADE MARK OF
SERGIO CATALANO
 via A. De Gasperi, tr. U. Foscolo, 3
 84018 Scafati (Sa) ITALY
 T/F +39 081 8508666
 info@join-lamp.com
 www.join-lamp.com
 p.iva 02974760650

MADE IN ITALY

INTERNATIONAL PATENT
 UTILITY MODEL
 TRADE MARK
 COPYRIGHT ON ARTIST DESIGN





THE SUSTAINABLE LIGHT 100% RECYCLABLE

DIAGO

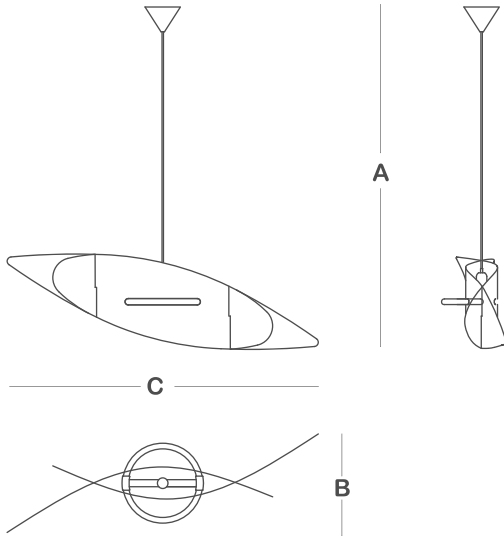

Confezione / Packaging Bag L



BREVETTO E MARCHIO DI / PATENT AND TRADE MARK OF
SERGIO CATALANO
 via A. De Gasperi, tr. U. Foscolo, 3
 84018 Scafati (Sa) ITALY
 T/F +39 081 8508666
 info@join-lamp.com
 www.join-lamp.com
 p.iva 02974760650

Nome / Name	DIAGO
Designer	SERGIO CATALANO
Versione / Version	SOSPENSIONE / SUSPENSION
Dimensioni / Dimensions	A = max1550mm B = 240mm C = 890mm
Codici colore / Code colors	 S-DIA-BA (bianco-arancio/white-orange)  S-DIA-BV (bianco-verde/white-verde)  S-DIA-BR (bianco-rosso/white-red)
Materiali / Materials	FRIPOLAN rosone in PP / rosette in PP
Dimensioni confezione / Package size	16x71xh40cm
Lampada inclusa / Bulb included *	1x24W E27 FBC Ø225mm

* Le caratteristiche della lampada inclusa nella confezione potrebbero variare leggermente
 The characteristics of lamp included in the package may vary slightly

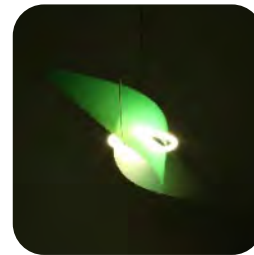

bianco-verde
white-green



bianco-rosso
white-red

MADE IN ITALY

INTERNATIONAL PATENT
 UTILITY MODEL
 TRADE MARK
 COPYRIGHT ON ARTIST DESIGN





join-lamp.com[®] THE SUSTAINABLE LIGHT 100% RECYCLABLE



Consorzio n° 1677

Reg. A.E.E. N° IT1301000007819

ECR assolto DLgs 151/05 - art. 10, comma 2

BREVETTO E MARCHIO DI / PATENT AND TRADE MARK OF: SERGIO CATALANO

join-lamp.com di **SERGIO CATALANO**

via A. De Gasperi, tr. U. Foscolo, 3

84018 Scafati (Sa) ITALY

T/F +39 081 8508666

info@join-lamp.com

www.join-lamp.com

p.iva 02974760650

N. Iscr. REA SA - 411210

Membro del collettivo
Member of collective



MADE IN ITALY

INTERNATIONAL PATENT
UTILITY MODEL
TRADE MARK
COPYRIGHT ON ARTIST DESIGN

